

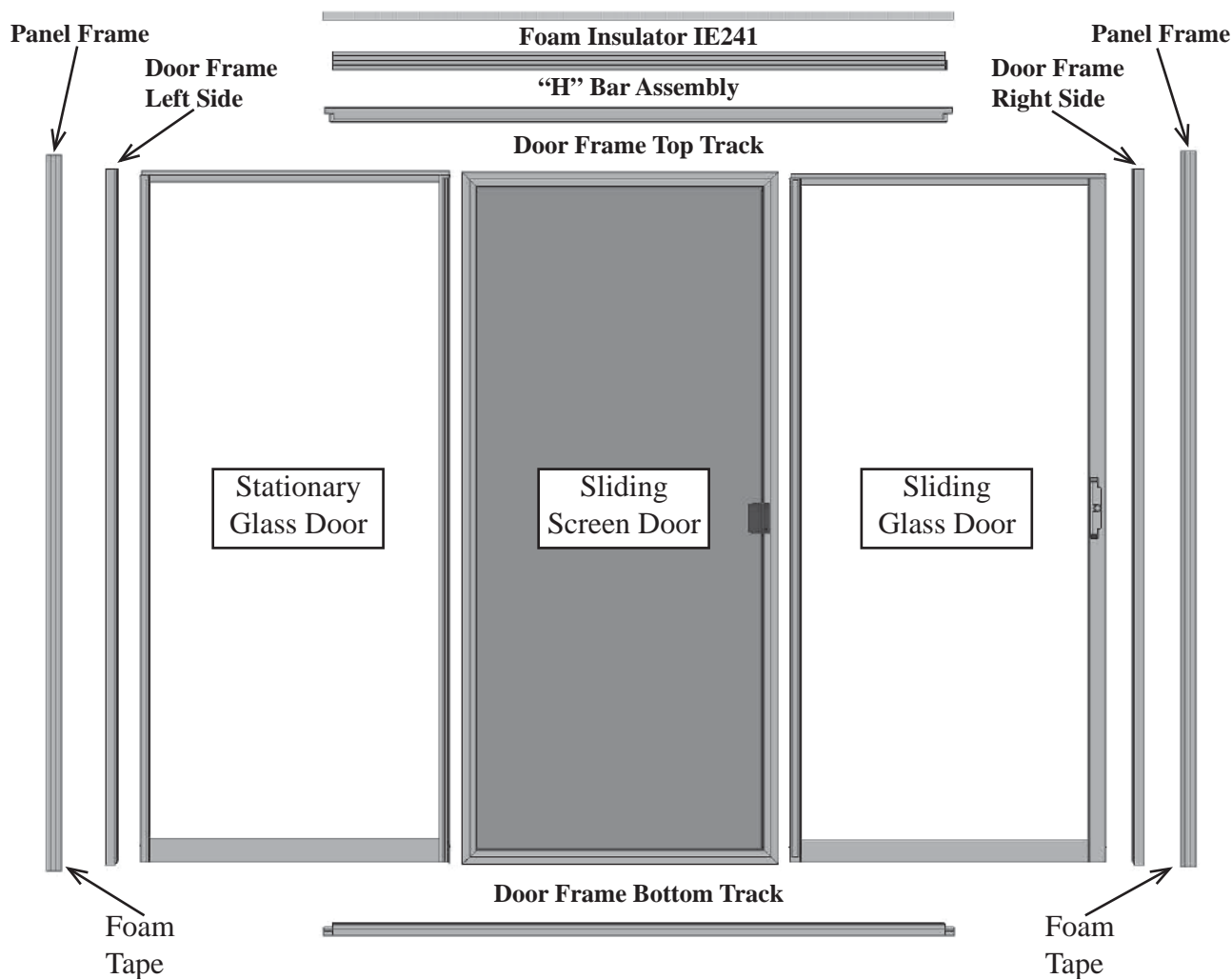

## All-Season Sunroom Sliding Glass Door Installation Instructions



Read the instructions before starting the job. They explain the steps required to produce a finished product that will meet factory specifications.

**All references to "Left" and "Right" are while facing the home.**





Check the material received.  
Match your shipment with the Bill of Materials.  
If there is a shortage or wrong material,  
call Dealer Service immediately.

Safety is important!  
Wear Safety Glasses and Work Gloves.  
Follow all safety practices while assembling  
and installing this product.

Dura-Bilt Products, Inc. P.O. Box 188 Wellsburg, N.Y. 14894

Dealer Service 570-596-2000 E-Mail [info@durabilt.com](mailto:info@durabilt.com)

DURA-BILT RESERVES THE RIGHT TO CHANGE DESIGN AND/OR SPECIFICATIONS WITHOUT NOTICE.

Fasteners	Description
	#8 x 1/2" Self Drilling Screw
	#10-24 x 1-3/8" Flat Phillips Screw
	#8 x 1/2" Flat Phillips Sheet Metal Screw
	#8 x 1/2" Indented Hex Sheet Metal Screw
	#8 x 1" Slotted Hex Washer Head Sheet Metal Screw

## Tools Needed

Drill  
Level  
Hammer  
Caulk Gun  
Utility Knife  
Silicone Lubricant

Tape Measure  
Chalk Line  
Screw Gun  
Vise Grips  
Hack Saw  
Phillips Screwdriver

1/8" & 1/4" Drill Bits

1/4" Nut Driver Bit with Magnetic Heads

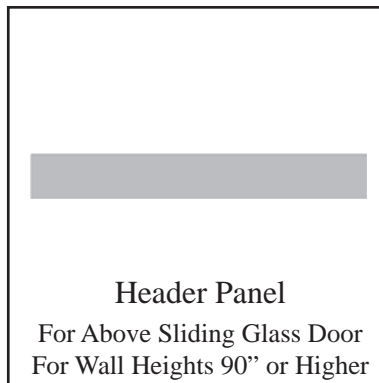
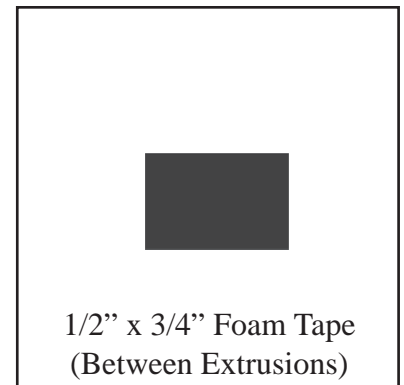
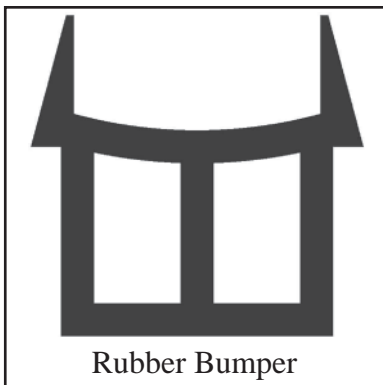

## Extrusions and Components

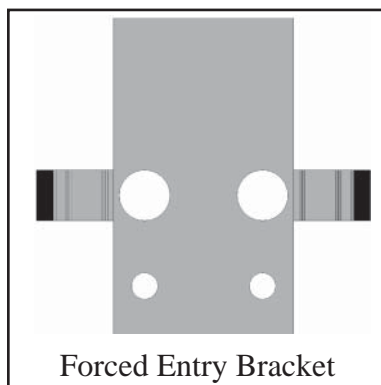
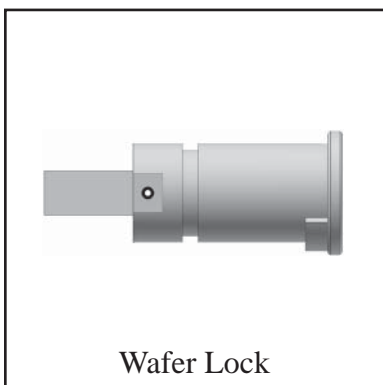
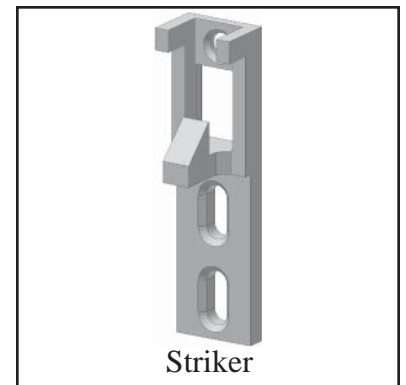
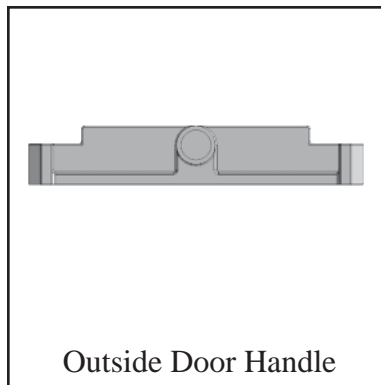
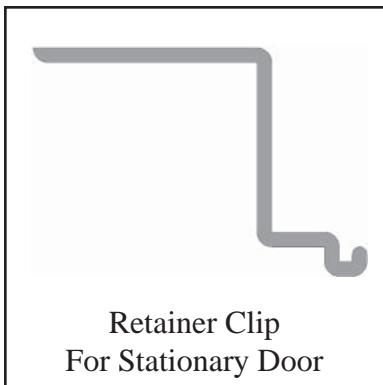
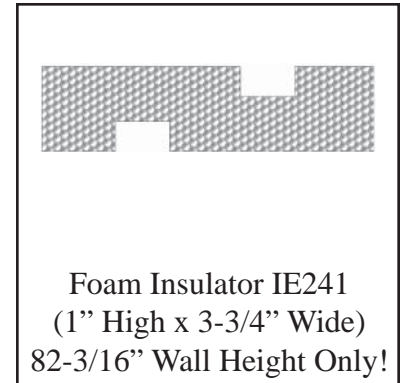
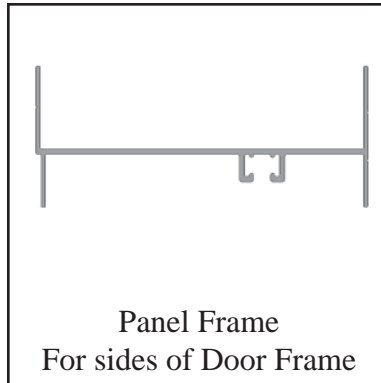
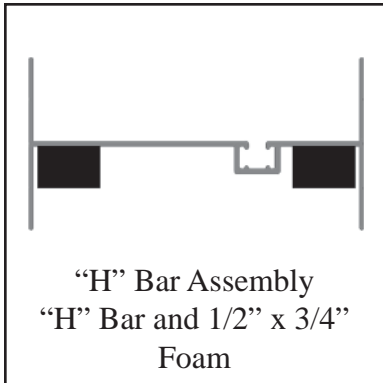
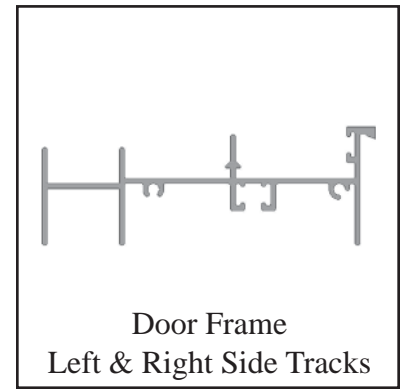
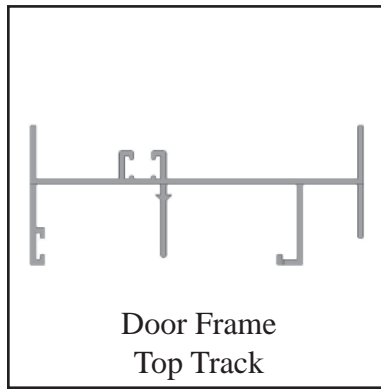
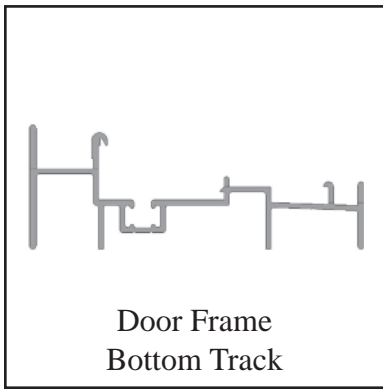

# All-Season Sunroom Sliding Glass Door Installation

## Assemble Door Frames

Lay the Frame sections on a flat surface in their proper positions. Sides of the Frame have the bottom ends stepped to fit the threshold.

**Note:** Insides of Frame have insulation strips. Fasten top and threshold frame sections to side frame sections with two #8 x 1" hex head screws in each corner.

**Caution!** It is critical that frame be made square before fastening together. An easy check is to be sure that corner-to-corner diagonal measurements are the same.

Caulk joint where side frames and threshold meet. Caulk all around edges of this joint on outside of both right and left sides.

**Do not caulk on inside.**

Locate two Panel Frames and apply (2) two strips of 1/2" x 3/4" Foam Tape as shown. The Foam Tape should go from the bottom of the Panel Frame to the top of the Door Frame Top Track. This will allow room for the Foam Insulator IE241 or the Header Panel. Simply slip the Panel Frames on the Left and Right Side Tracks of the Door Frame.

**Be sure the Panel Frame end with routed holes for Floor Channel are at the bottom of the Frame.**

Panel Frames do not need to be screwed to the door frame.

This unit is now installed in the wall of the room just as any other Wall Panel.

Install pre-cut Header H-Bar Assembly(s) on the top of Door Frame Top Track. This should fit between the Panel Frames and over the Door Frame Top Track.

Sliding Door Units for walls 90" or higher call for Solid Header Panels. Insert the pre-cut Header Panel(s) in the H-Bar and attach with #8 x 1/2" Self Drilling Screws.

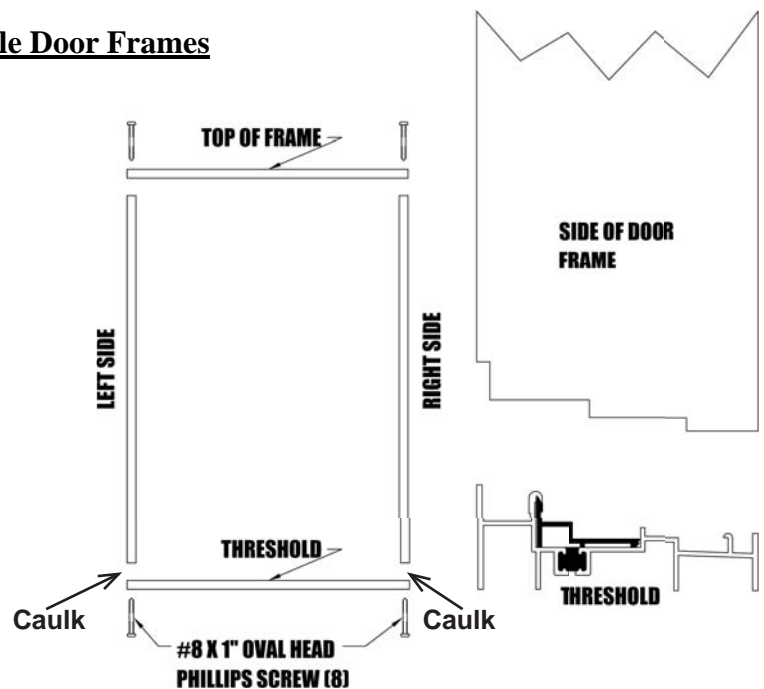

**Note:** High side of threshold is placed inside the room, the same way you installed the Floor Channel.

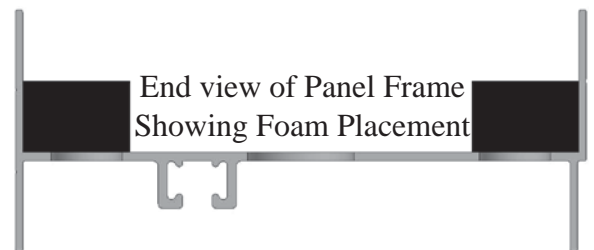

Side view of Panel Frame showing routed holes on Bottom

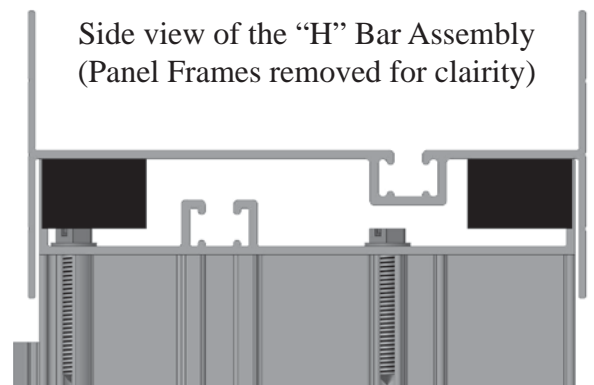

After the Room Walls are complete, the Glass Door Panels and the Screen Door can be installed in the frame.

Weep holes are suggested to drain the two outside channels of the threshold and the Floor Channel. Drill 1/4" weep holes every 10". Also drill the Floor Channel directly below the hole drilled in threshold.

### Installing Doors

**Doors can be assembled into frames for either Right or Left opening. Right Hand shown in the illustration, Left Hand opposite. View is from outside the room.** (Note: the Stationary Door does not have rollers)

The Sliding Glass Door is always in the inside track. Stationary Door is in the center track. The Screen Door is in the outside track. See illustration.

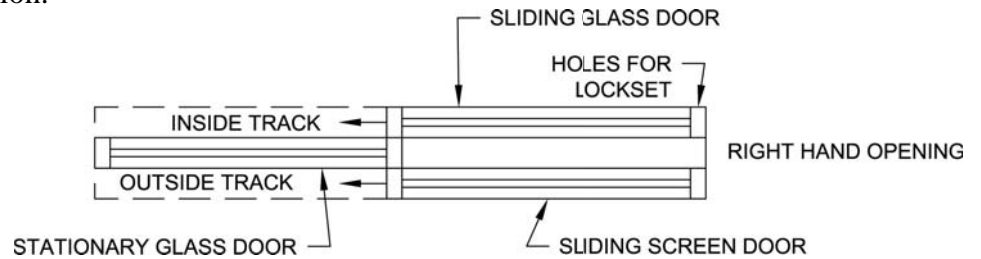

After you have determined whether the Sliding Door is going to open from the Left or Right. Install the Stationary Door in the center track first by inserting the top of the Door into the Door Frame Top Track. If the Sliding Door is right hand opening, slide the Stationary Door all of the way to the left.

### Installing The Forced Entry Bracket on the Stationary Door

The Forced Entry Bracket is designed to keep an intruder from lifting the unit out of the track. Install the Forced Entry Bracket using (2) two #8 x 1/2" Indented Hex Sheet Metal Screws. See Illustration.

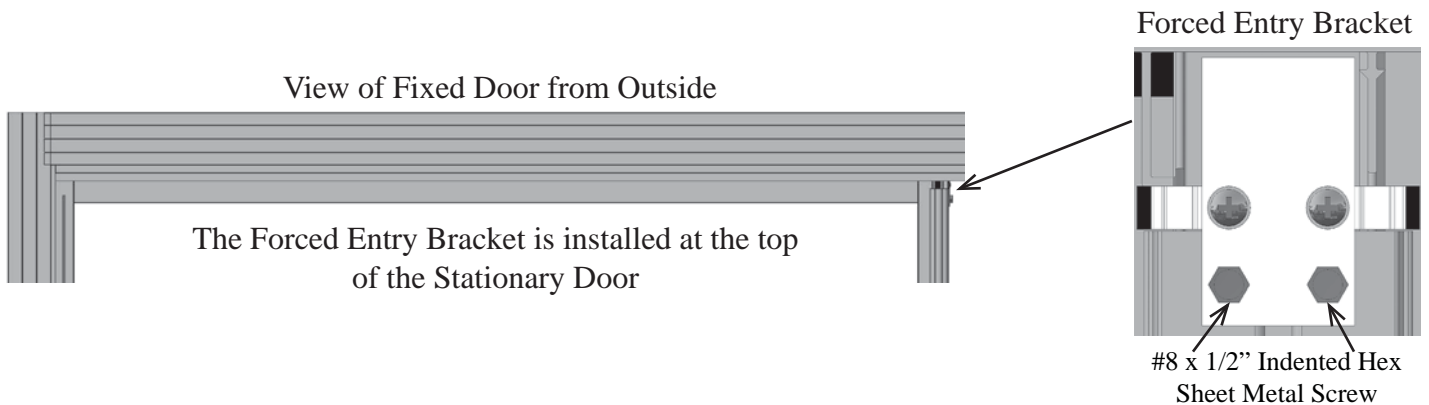

## Installing The Retainer Clips

Next you must install the Retainer Clips inside the room to hold the Stationary Door in place. There are (3) Retainer Clips, (2) two of them are 2" long and the third one is 5-1/2" long. Use (2) two #8 x 1/2" Self Drilling Screws to attach each Retainer Clip. The 2" Retainer Clips are installed 12" down from the top and 12" up from the bottom. The 5-1/2" Retainer Clip is installed in the center of the Stationary Door. The notch in the Retainer Clips goes over the small lip on the Stationary Door. The Retainer Clips are attached to the Door Frame Side Track with the #8 x 1/2" Self Drilling Screws. All three Retainer Clips are required to hold the Stationary Door in place to meet wind load requirements.

2" Retainer Clip

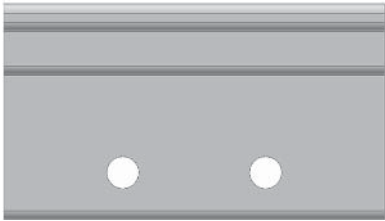

5-1/2" Retainer Clip

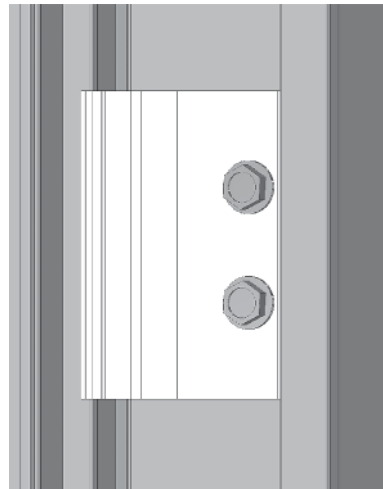
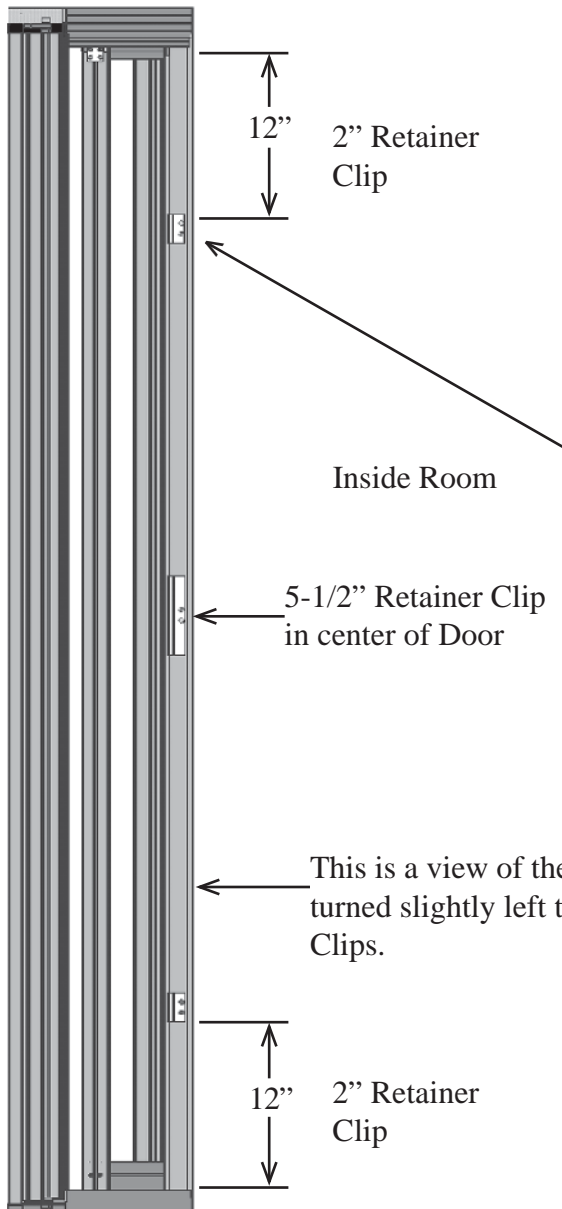
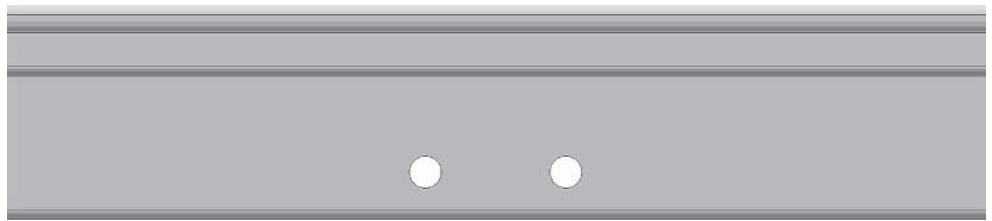

**Note:** Enlarged view of the 2" Retainer Clip. The Clip will also cover up the 9/32" hole in the Door Frame Left or Right Side Tracks, depending on which side the Sliding Door opens from.

## Installing The Sliding Door

The Sliding Glass Door has two built-in ball bearing roller glides in the bottom of the door. Before installing the door into the Door Frame Assembly adjust the ball bearing roller to bring the edge of the roller flush with the bottom edge of the door.

Install the Sliding Door by inserting the top of the Door into the top of the inside track of the Door Frame Assembly, then set the Sliding Door rollers down on top of the roller track

**Adjusting the Doors**—Adjust the ball bearing rollers by turning the adjusting screw until the panel is square in the track assembly. Turn the screw driver clockwise to raise the door. Turn counter-clockwise to lower the door.

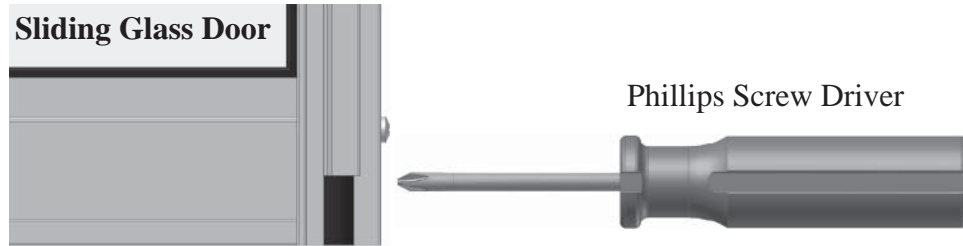

## Installing The Rubber Bumpers

The Round Rubber Bumpers are installed on the handle side of the Sliding Glass Door. The Bumpers fit into the (2) two 9/32” holes in the Door Frame Left or Right Side Tracks. These Bumpers cushion the door when it is closed.

The Large Rubber Bumper fits into the Door Frame Left or Right Side Track and can sit on top of the 5-1/2” Retainer Clip for vertical location. This is a bump for the Sliding Glass Door to hit when it is opened

**Round Rubber Bumper in Side Track**



**Large Rubber Bumper in Side Track**

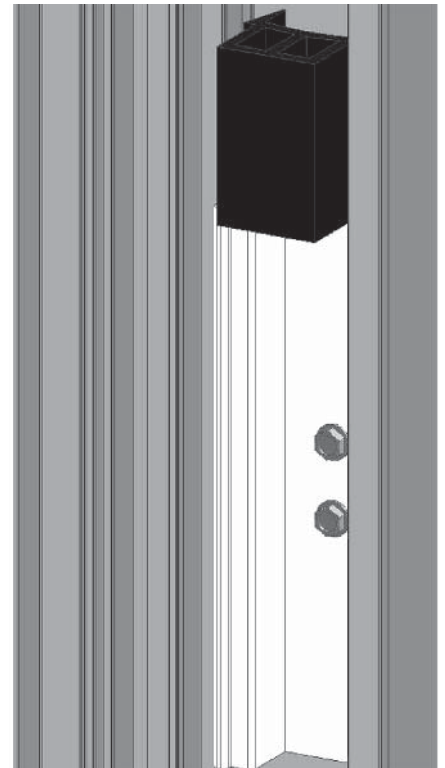

## Inside Handle Information



The Inside Handle is ordinarily furnished as shown here, for use with Right-Hand Door.

The inside handle is normally furnished as shown here so that when the door is pushed closed it will automatically unlatch, thereby preventing someone from accidentally locking oneself out of the house. **If the flat spring was placed so that it was against the flat side of the latch, when you shut the door you would be locked out of the house.**

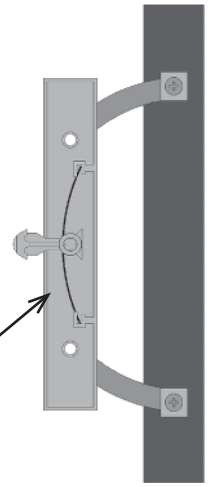

The flat spring must look like illustration for the Automatic Un-latching to work.

---

TO CHANGE FOR USE WITH LEFT HAND DOOR - lift the flat spring out carefully, remove the screw from the knob and rotate the knob 180 degrees. Replace the knob, then the screw, then the spring. The Inside handle is now suitable for use with a left-hand door, as shown here.

**Note:** The knob is again pointing up when in the latched position.



---

## Striker Installation

The Striker will be mounted in the Door Frame Left or Right Side Track (Depending on whether the Door opens from the left or right) using (3) three #8 x 1/2" flat phillips sheet metal screws.

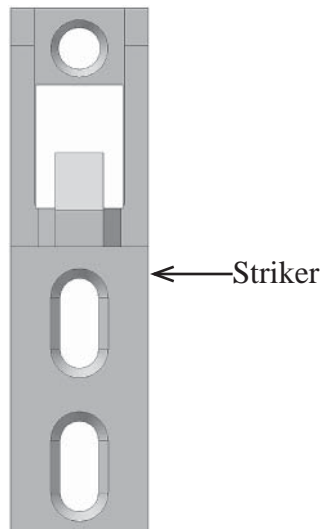

## Striker Installation

(Continued)

With this Striker; simply place into wider part of jamb allowing positive positioning lug to be inserted in the rectangular hole in the Door. Position the Striker approximately where it will be positioned and put a mark in the center of the two oblong holes and drill with a 3/32" drill bit then adjust the location of the strike and fasten with (2) two #8 x 1/2" flat phillips sheet metal screws.

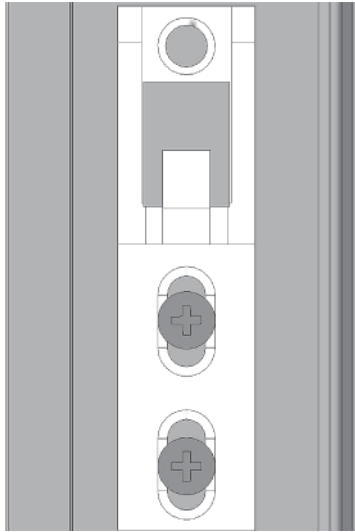

View of Sliding Glass Door  
Turned for clarity.

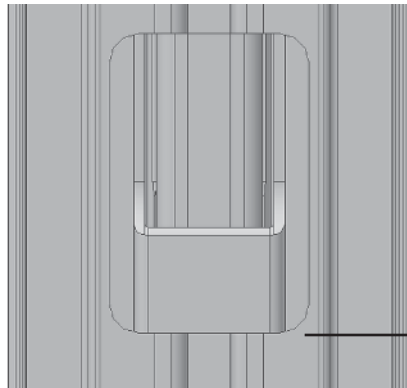

View of Strike  
in Door jam..

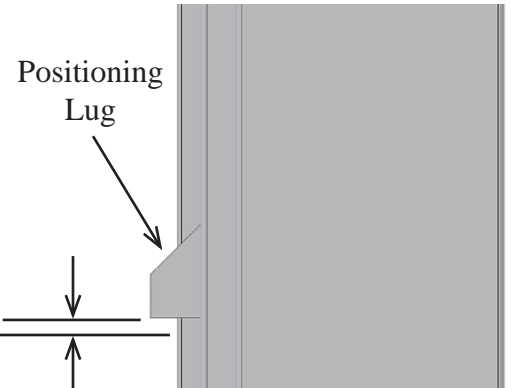

1/64" CLEARANCE MAX.  
Between Striker hook and bottom  
edge of cut-out in Door.

After the Strike has been properly adjusted and tightened, drill a 3/32" hole for the third screw (at top of strike). This screw secures the strike for maximum forced entry protection.

View of Strike  
with all three screws.

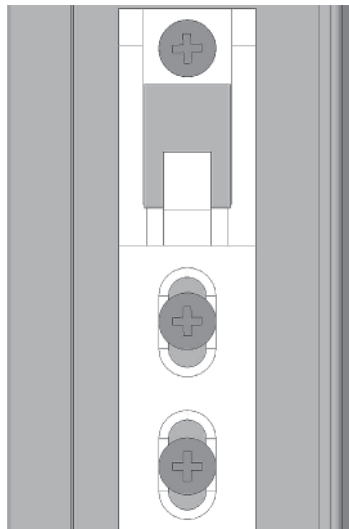

## Installing The Sliding Door Handles

Inside Handle - Turn knob to latching position as shown. Hold inside handle horizontal and insert latch into cutout in door stile as shown. When latch is thru stile, turn handle to vertical position so that latch appears at rectangular cutout in edge of stile. Press two bosses on the handle into the corresponding holes in stile. Hold handle in place temporarily.

Outside Handle - place in position on outside of stile so that the two screw bosses drop into the corresponding holes in the stile. (Note: If outside handle is equipped with the wafer lock, first insert lock tongue in hole of the latch). Assemble using (2) two 1-3/8" flat phillips screws thru the inside handle. Push them thru the stile and into corresponding holes of outside handle. Tighten securely.



## Installing The Optional Wafer Lock

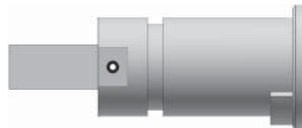

The Wafer Lock Knockout Plug **must** be knocked out from the **back side only!** Do not - repeat - do not attempt to punch out the plug from the front face.

Use a hammer and a screw driver or equivalent to knock out the plug from the Back Side. Then use a small round file or a 1/2" drill bit or both to remove burr.

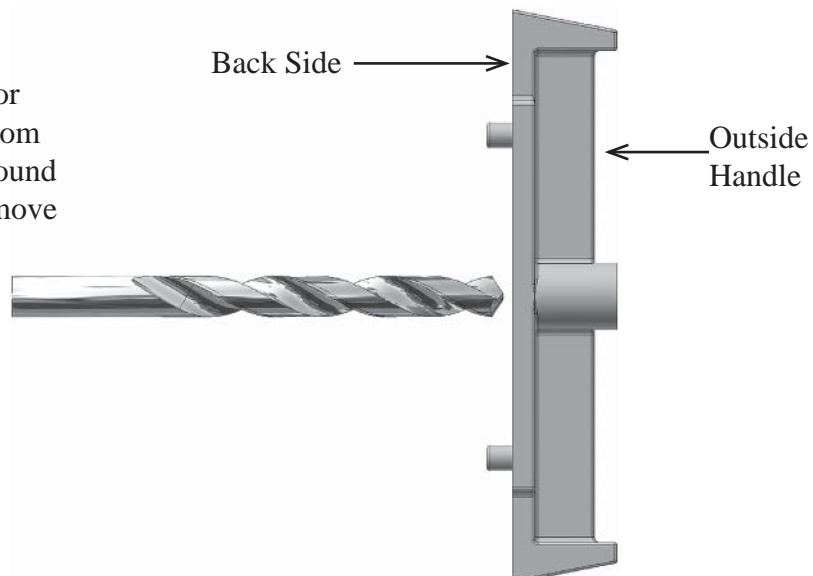

After you knock out the plug, you must clean out the unavoidable burr with a round file or a 1/2" drill bit. Again, be sure to insert the file or drill bit from the **back side** and work it around several times to remove the burr. If the key lock is still difficult to install, make a few more passes with the file or drill bit.

Caution: After installation is complete, check the Sliding Door and make sure that it can not be lifted out, if it can, strike has not been set correctly.

### **Installing The Screen Door**

Roller Adjustment - Follow these steps after screen door is installed to achieve a proper fit.

1. Release each roller at the top by turning the adjustment button in the direction shown (less than 1/4 turn is needed).
2. Repeat step above at the bottom, but continue to turn bottom adjustment buttons approximately 1/2 turn or less.

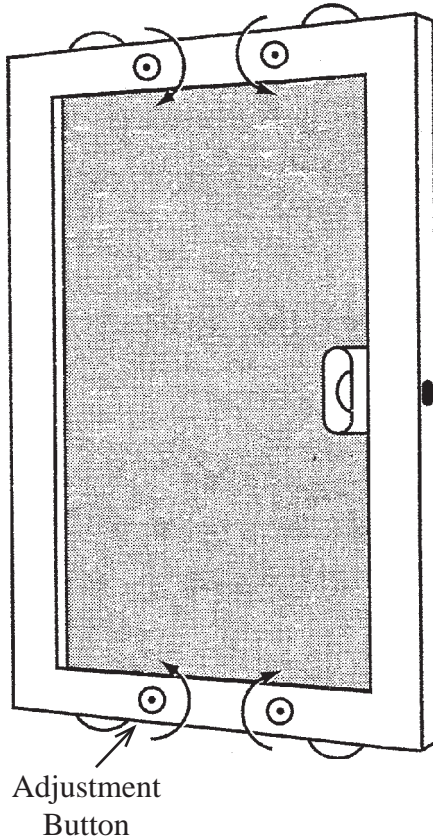

## Installing The Screen Door Strike

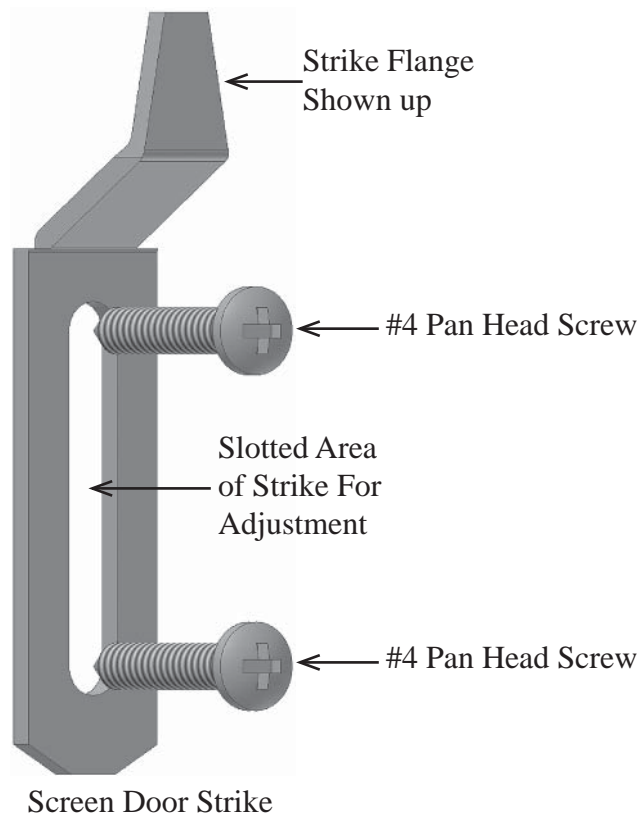

Determine if the strike flange should be positioned facing up or down (this depends on your door opening direction). The most favorable position is with the strike flange extending up so that when the screen is closed the latch lever is moved down to lock the Screen Door.

1. Close the Door into the Frame and mark the position to install the Strike.
2. If pre-drilled holes already exist in the frame, install the strike through them with screws supplied. If no holes exist, 5/64" holes will have to be drilled to install latch strike.

Note: Strike is slotted to give adjustment allowance (up or down).

**Always adjust the strike so that positive latching occurs before tightening the screws.**